

Pressure-limiting valve type MV, SV and DMV

Pressure-limiting valves and sequence valves are types of pressure control valves. Pressure-limiting valves safeguard the system against excessive system pressure or limit the operation pressure. Sequence valves generate a constant pressure difference between the inlet and outlet flow.

Type MV and SV is a directly controlled valve that is damped as standard. Undamped variants are also available for special operating conditions.

Features and benefits:

- Operating pressures up to 700 bar
- Various adjustment options
- Numerous configurations

Intended applications:

- General hydraulic systems
- Test benches
- Hydraulic tools



Nomenclature:	Pressure limiting valve, sequence valves (directly controlled)
Design:	Individual valve for pipe connection Screw-in valve Individual manifold mounting valve Assembly kit
Adjustment:	Tool adjustable Manually adjustable
p_{max}:	700 bar
Q_{max}:	5 ... 160 l/min

Design and order coding example

MVS 52 B R X - 650

Pressure setting]

Optionally without dampening (X)

Adjustability (while pressurized)

- Tool adjustable
- Manually adjustable
- Adjustable with turn knob (self-locking/lockable)





Pressure range and flow Pressure ranges A, B, C, E and F

Basic type, size Type MV.., DMV.. and SV..

Additional versions

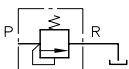
- Multiple pressure limiting valves (2, 3, 4, 5 valves in parallel)
- Pressure-limiting valves with unit approval (TÜV valves) (type MVX, MVSX, MVEX, MVPX, SVX, size 4, 5 and 6)
- Various actuations: ball head for controls via cam, lever etc. (type MVG and MVP only)

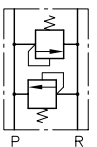
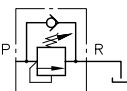
Function

	MV ¹⁾	MVS MVG	MVE	SV	MVP	DMV	MVCS MVGC	SVC	MVB
									
Function	Pressure limiting valve	Pressure limiting valve and differential pressure regulators				Pressure limiting valve	Pressure-limiting valve with free reflux R→P via a bypass check valve		Pressure limiting valve and differential pressure regulators
Brief description	Corner valve for pipe connection	Corner valve for pipe connection	Screw-in valve	Straight-way valve for straight pipe installation	Manifold mounting valve	Twin valve as shock valve for hydraulic motors	Corner valve for pipe connection	Straight-way valve for straight pipe installation	Assembly kit
Size	4, 5, 6	13, 14, 4, 5, 6, 8	13, 14, 4, 5, 6, 8	4, 5, 6, 8	13, 14, 4, 5, 6, 8	4, 5, 6, 8	13, 14, 4, 5, 6	4, 5, 6	4, 5, 6, 8
p_{perm R} [bar]	20	500	500	500	500	350	500	500	200

1) Only size 4, 5, 6, and 8
Type MVG and MVGC only size 13 and 14

Example circuit:

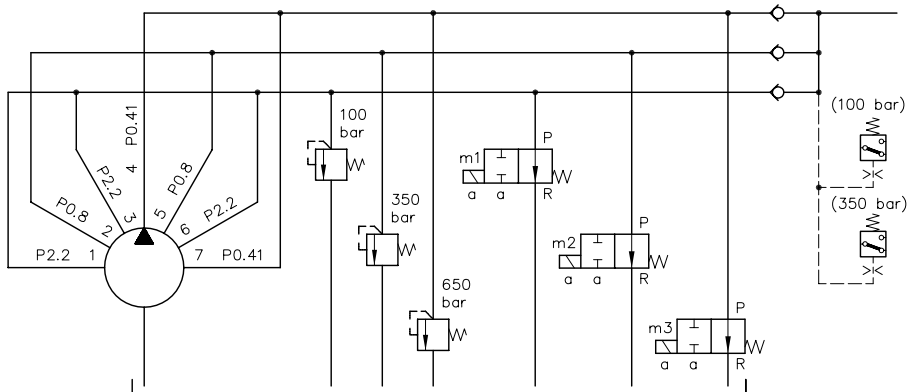

General parameters and dimensions

MV, MVS

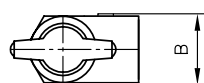
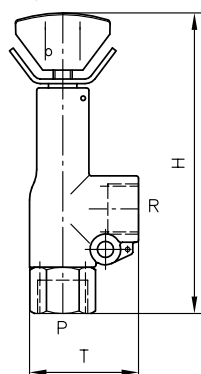

MVG

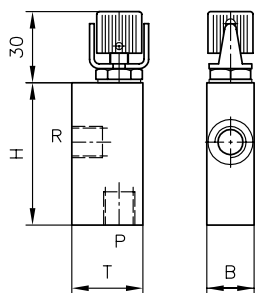

DMV

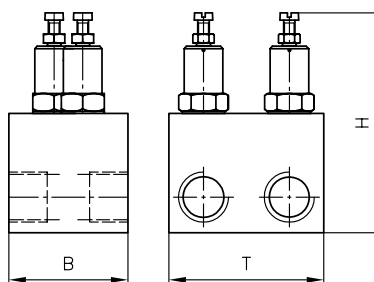

SV, SVC

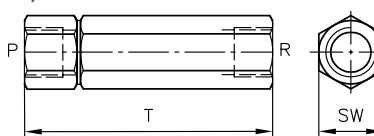

See following table for dimensions

	Size	Dimensions [mm]			m [kg]	Size	Pressure range/Flow	Ports (BSPP) ¹⁾
		H _{max}	B/SW	T _{max}				
MV, MVS, MVCS, MVE	4	126	24	48	0.3	4	F: 80/20 E: 160/20 C: 315/20 B: 500/20 A: 700/12	G 1/4, G 3/8
	5	142	29	60	0.4			
	6	164	36	70	0.7			
	8	208	40	60	2.0			
DMV	4	107	40	52	0.7	5	F: 80/40 E: 160/40 C: 315/40 B: 500/40 A: 700/20	G 3/8, G 1/2
	5	123	50	65	1.3			
	6	142.5	60	75	1.8			
	8	192	80	96	4.5			
MVP	4	102	28	35	0.3	6	F: 80/75 E: 160/75 C: 315/75 B: 500/75 A: 700/40	G 1/2 G 3/4
	5	113	32	40	0.5			
	6	133	35	50	0.8			
	8	172	50	60	1.6			
	13, 14	82	29	50	0.3			
MVE	13, 14	75	SW 27	-	0.1	8	E: 160/160 C: 315/160 Bi: 500/160 A: 700/75	G 3/4, G 1
MVG, MVGC	13, 14	94	20	42	0.3	13	H: 700/5	G 1/4
SV, SVC	4	-	SW 22	87	0.2	14	N: 50/8 M: 200/8 H: 400/8	G 1/4
	5	-	SW 27	108	0.4			
	6	-	SW 32	132	0.9			
SV	8	-	SW 41	157	0.9			

1) For pipe connection versions only

Associated technical data sheets:

- [Pressure-limiting valve type MV, SV and DMV: D 7000/1](#)
- [Pressure-limiting valve and pre-load valve type MVG, MVE, and MVP: D 3726](#)
- [Pressure-limiting valve \(installation kit\) type MV: D 7000 E/1](#)
- [Multiple pressure-limiting valve type MV: D 7000 M](#)
- [Pressure-limiting valve, with unit approval type MV .X: D 7000 TUV](#)

Similar products:

- [Pressure valve type CMV, CMVZ, CSV and CSVZ: D 7710 MV](#)
- [Pressure-limiting valve, pilot-controlled type DV, DVE and DF: D 4350](#)
- [Pressure valve with check valve type AL, AE and AS: D 6170](#)